

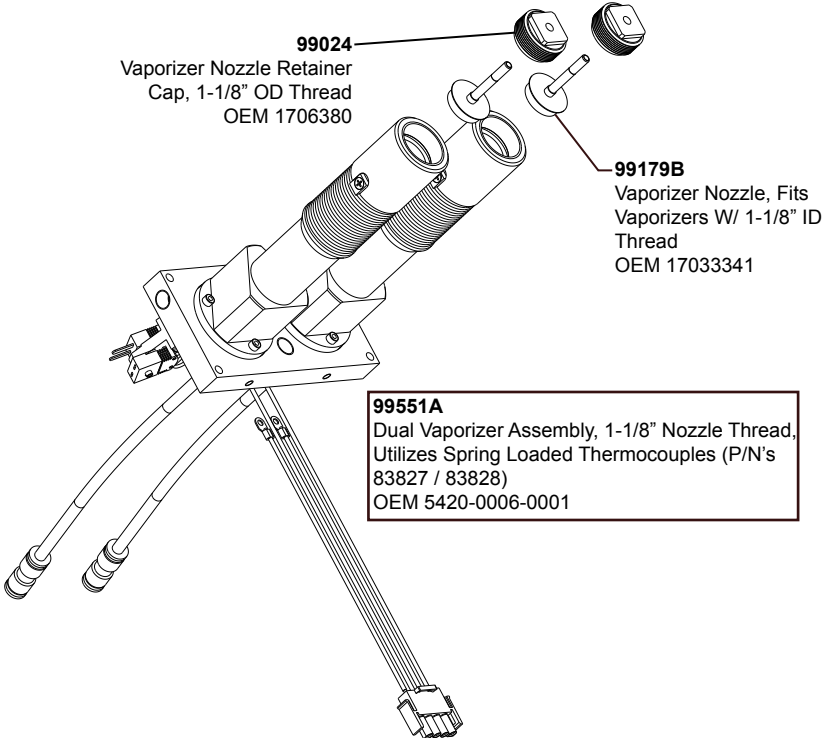

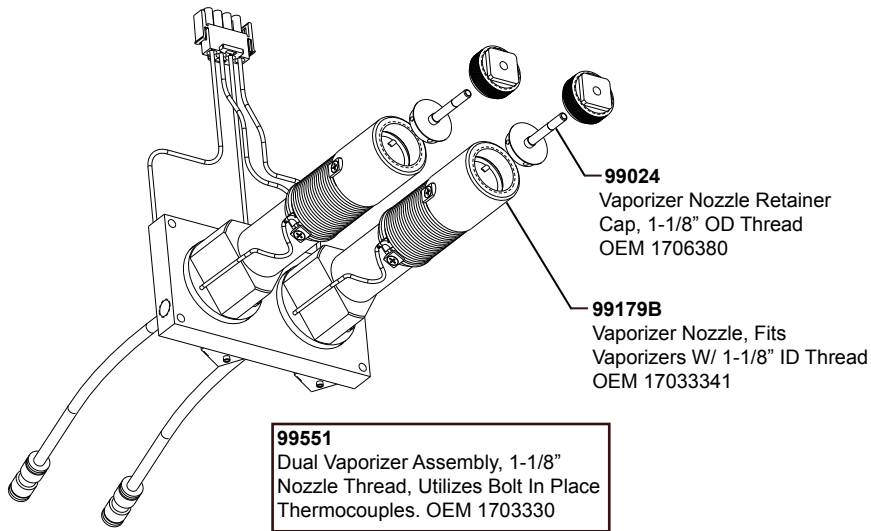













Dual Vaporizer Assemblies for Axcelis



DUAL VAPORIZER COMPONENTS

-  Vaporizer Nozzle Retainer Cap, 1-1/8" OD Thread
P/N 99024 / OEM 1706380
-  Vaporizer Nozzle Retainer For SB
P/N 99147 / OEM 1739150
-  Vaporizer Nozzle Retainer Cap 1-1/4" OD Thread
P/N 99337 / OEM 17036190 Rev. B
-  Vaporizer Heat Shield
P/N 99336 / OEM 1152240
-  Vaporizer Nozzle, W/ 1-1/8" ID Thread
P/N 99116 / OEM 1706370
-  Vaporizer Nozzle, For SB
P/N 99146 / OEM 1739160
-  Vaporizer Nozzle For SB
P/N 99146A / OEM 1152620
-  Vaporizer Nozzle, 1-1/8" OD Thread
P/N 99179 / OEM 1703340
-  Thermocouple Probe, 6" Male Connector
P/N 83830 / OEM 1210070
-  Thermocouple Probe, 6" Female Connector
P/N 83830F / OEM 1210060
-  Vaporizer Thermocouple, Male Connector (Spring Loaded)
P/N 83827 / OEM 7435-0010-0001
-  Vaporizer Thermocouple, Female Connector (Spring Loaded)
P/N 83828 / OEM 7435-0011-0001
-  Vaporizer Crucible
P/N 99145A / OEM N/A

