

For use in **DF-3000, 350D, CF-3000, 200-20A2F, 300XP, DF-4, DF-5, CF-4, and CF-5** Implanters.

**P/N: 51095**

OEM C04287001

D04287001

### Electrostatic Quadrupole Assembly

- B-1** Exploded view, magnets and rings
- B-2** Pole piece column, exploded to show detail
- B-3** Wiring diagram

We offer cleaning and refurbishing services for the quadrupole assembly.

For **P/N 51095**, refer to **P/N 51095R**.

Standard service will clean all components and will replace:

**P/N 51065 (24)** see page **B-2** and all wire.

*Any other repairs or replacements to this assembly will be quoted on a case by case basis, upon inspection of the assembly by our technical staff.*

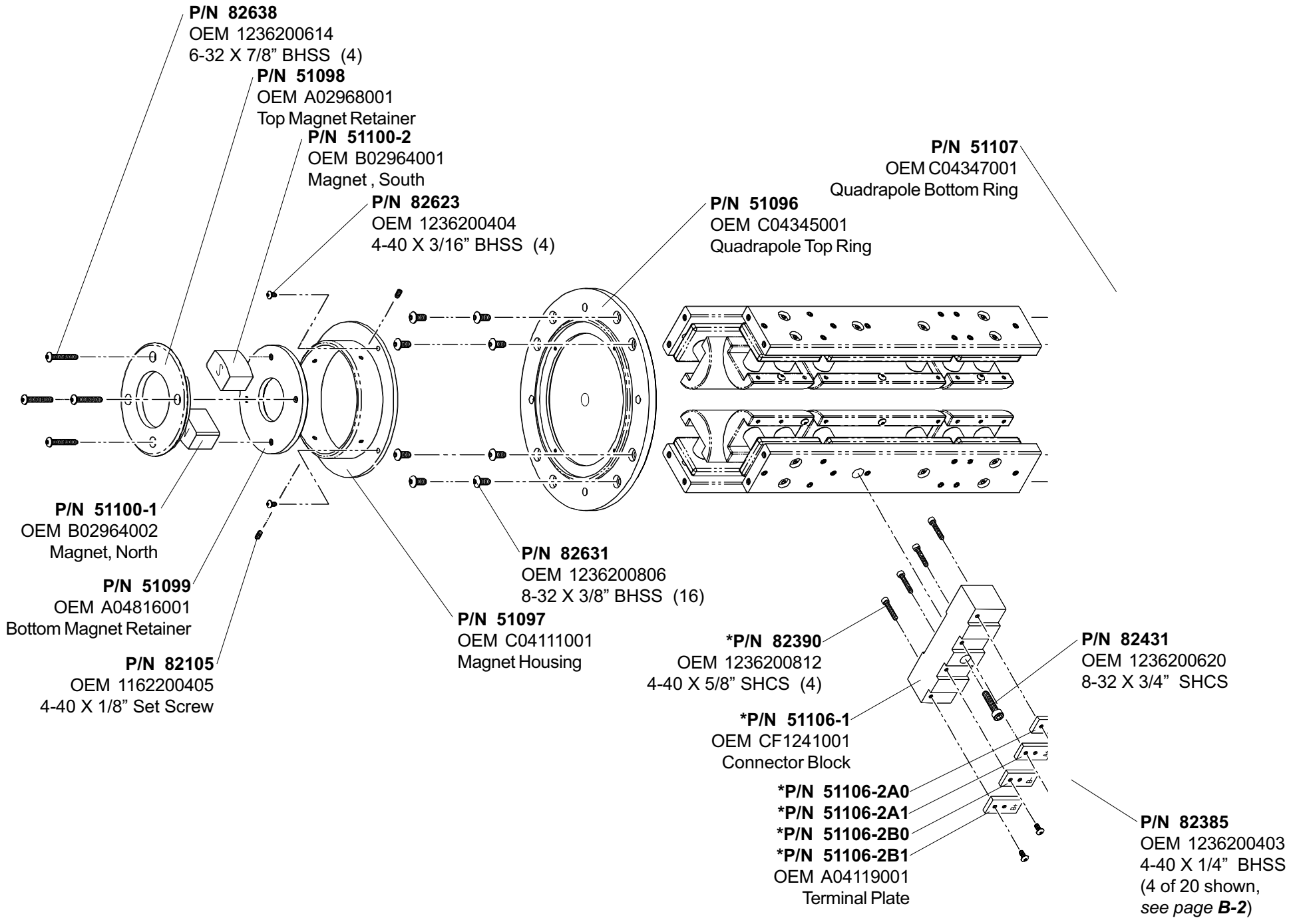

\*These items are included in the purchase of **P/N 51106**.

The components for each of the pole piece columns are identical. Only one is shown for clarity.

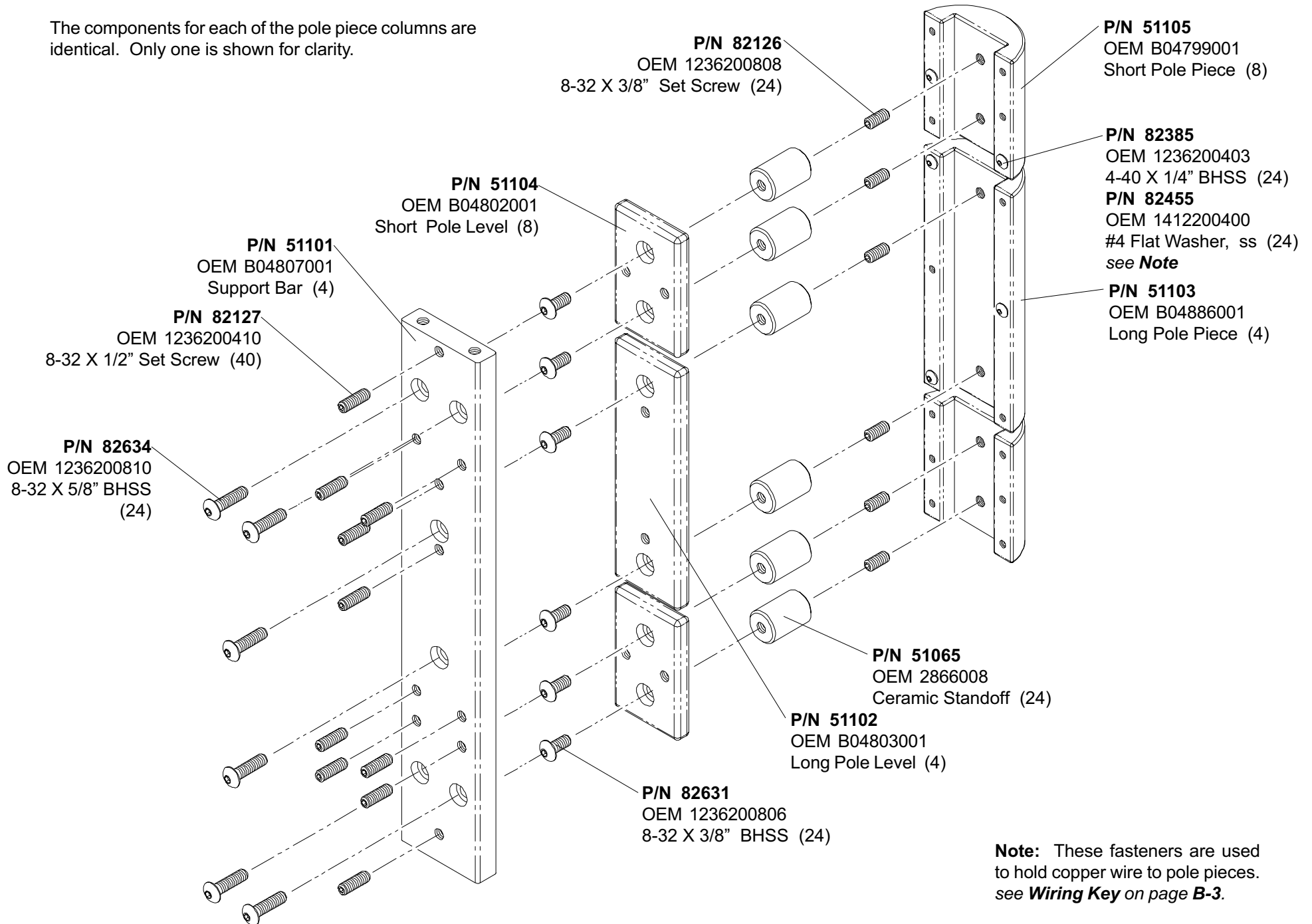

**Note:** These fasteners are used to hold copper wire to pole pieces. see **Wiring Key** on page **B-3**.

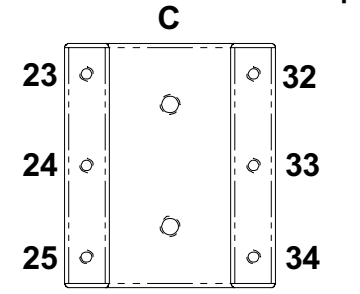
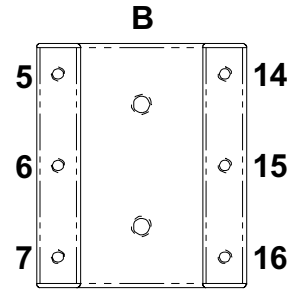
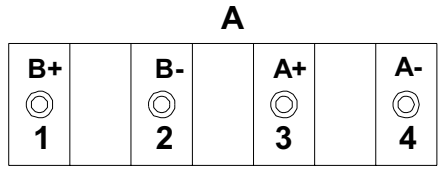

Top

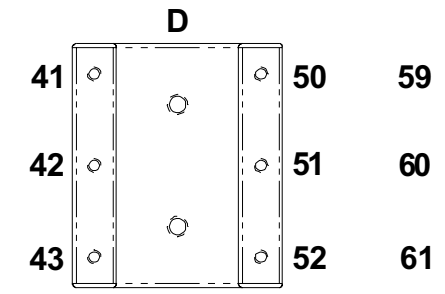

E

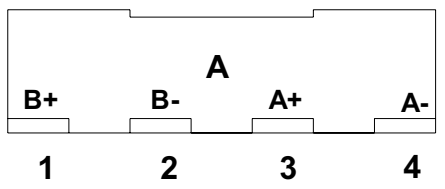
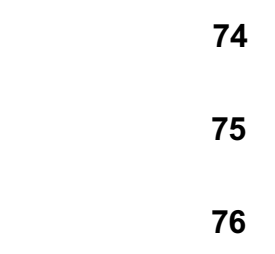
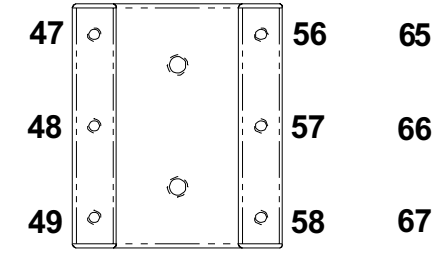
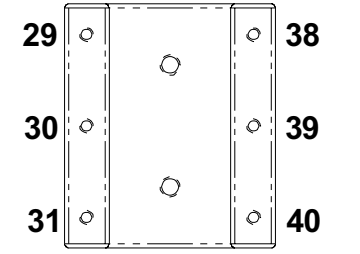
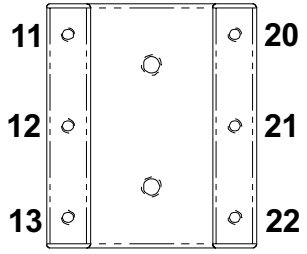
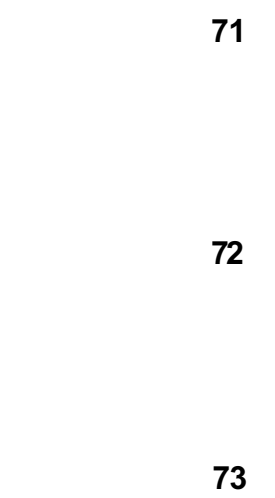
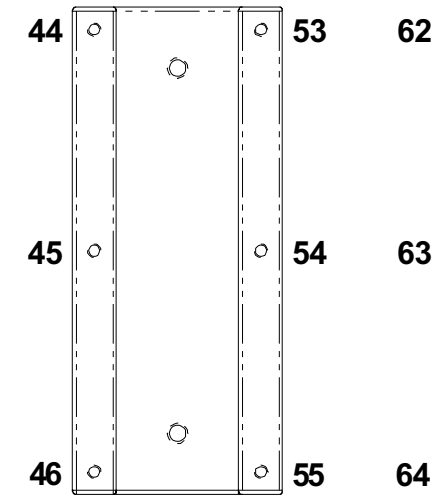
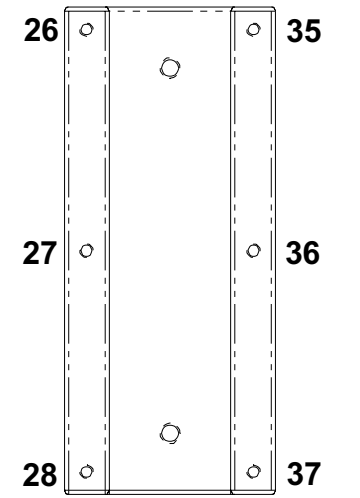
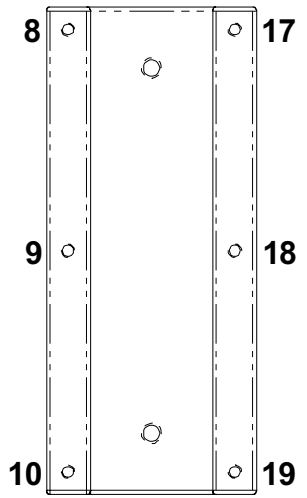
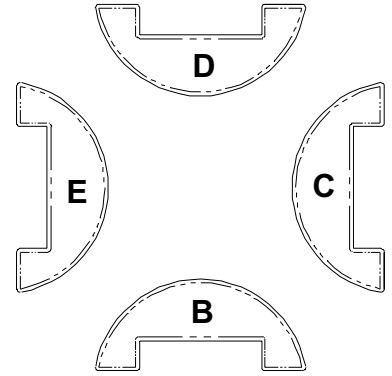
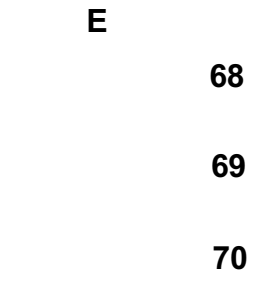

Bottom

**Wiring Key**

**P/N 82857**  
 #20 AWG Solid Tinned Copper Wire  
 Wire can be purchased by the foot, but is included with quadrapole cleaning and refurbishment.

Long Pole Pieces		Short Pole Pieces	
<b>B+ Circuit</b>	<b>B- Circuit</b>	<b>A+ Circuit</b>	<b>A- Circuit</b>
A1 - E71	A2 - B8	A3 - B16	A4 - C24
E72 - C36	B10 - D55	B6 - D51	C23 - E68
		B16 - B20	E70 - E74
		D43 - D47	C34 - C38